

7.

⬡ 4 mm - 2,5 Nm

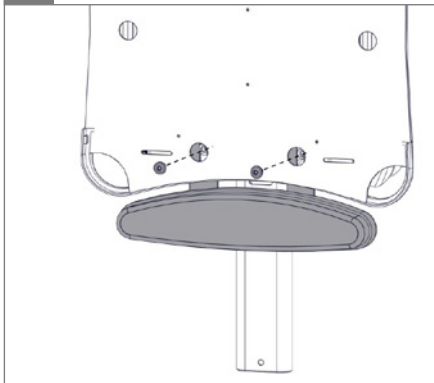

8.



9.

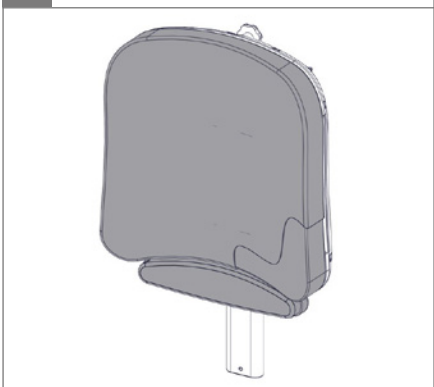

10.

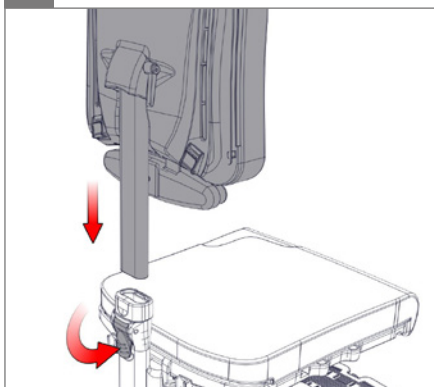

11.

⬡ 5 mm 🔑 10 mm

